

## Installation Manual

### SICRIT® MS Interface TX2 / TX3 / TX7

for Thermo Scientific LTQ, LTQ Velos, Orbitrap Elite and Exactive Series



Release November 2024

This manual must be stored carefully and must be at hand to any user of the described system.

In addition to this guide, Plasmion GmbH provides manuals for installation and operation of the SICRIT® Ion Source and additional modules for coupling with chromatography etc.

Please check for updated versions of manuals on [www.plasmion.com](http://www.plasmion.com).



**Attention!**

Please read and understand this manual before operating the described system. In case you discover obvious errors or contradictions for your product, contact the manufacturer before operating the system.





The content of this document has been checked thoroughly and is considered to be reliable. However, Plasmion GmbH does not assume any responsibility for damage to foreign or its own products and instruments resulting from improper use or any combination of the product with other instruments. Plasmion GmbH is not liable for consecutive damage resulting from integration and/or operation of its products in/with other systems. If the system is used in any manner not specified by Plasmion GmbH, the protection of the system could be impaired. Plasmion GmbH is not responsible for ignoring the outlined safety guidelines or the misuse of this system.

The technology and application of the system described in this manual is covered by patents and patent applications and is used under license.

All trademarks are property of their respective owners.

## Safety Instructions

The following safety labels on the product and within this manual indicate safety risks and necessary precautions that arise during installation or from operating the products.

	<p>[Attention!], marks possible dangers to your safety and health.</p>
	<p>[Dangerous Voltage!], indicates parts and situations where there is the risk of exposure to dangerous electrical voltages.</p>
	<p>[Attention Hot Surface!], indicates potentially hot surfaces that might cause burning injuries if touched without protective gear.</p>
	<p>[Note], marks important information or advice, not related to safety issues.</p>

## Table of Content

1.	Intended Use of the SICRIT® MS Interfaces.....	1
1.1	The SICRIT® Technology .....	1
1.2	The SICRIT® MS Interface TX2 / TX3 for Thermo Scientific LC-MS instruments.....	1
2.	Installation of the SICRIT® MS Interface TX2 / TX3 to the MS Instrument.....	3
2.1	Steps before the installation of SICRIT® MS Interface TX2 / TX3 / TX7 .....	3
2.2	Installation of the SICRIT® Inlet capillary.....	4
2.3	Installation of the SICRIT® Ion source.....	5
2.4	Installation of the SICRIT® IonMax Source retrofit housing.....	6
3.	Launching the MS instrument with SICRIT® Ion Source Technology.....	8
4.	Service and Maintenance of the SICRIT® MS Interface TX2 / TX3 / TX7.....	9
4.1	Maintenance of the SICRIT® Ion transfer capillary and adapter parts .....	9
4.2	Cleaning of the SICRIT® Ion transfer capillary and adapter parts.....	9

## 1. Intended Use of the SICRIT® MS Interfaces

The system described is intended for use only in laboratory and/or R&D environment. If the system is used in a way not specified by the manufacturer, misused, or modified causing an infringement of the safety measures, Plasmion GmbH refuses any liability for consecutive damages in any form.

### 1.1 The SICRIT® Technology

Soft Ionization by Chemical Reaction In Transfer (SICRIT®) is a flow through ionization technique to be coupled with mass or ion mobility spectrometers. Inside the ion source a cold plasma is used for ionization of the analytes passing through. This enables direct gas phase measurements as well as coupling with chromatographic systems such as GC or HPLC. The latter requires additional coupling modules.

### 1.2 The SICRIT® MS Interface TX2 / TX3 for Thermo Scientific LC-MS instruments

The SICRIT® Interfaces TX2 and TX3 replace the standard housing of the Thermo Scientific *Ion Max API Source* and enables the coupling of the SICRIT® Ion source to the MS (Fig. 1). The interface set consist of:

- a source housing (a) with a plastic safety cover retrofitting Thermo IonMax housings that enables the MS to recognize the SICRIT® Ion source and protects the user during MS operation (Art.-Nr. 26-001),
- an ion transfer capillary (b, TX2 / TX3) to connect with the SICRIT® Ion source or an adapter (b, TX7), respectively

The SICRIT® Interface TX2 and TX3 are identical except for SICRIT® Ion transfer capillary. Here, Art.-Nr. 16-004 replaces the original ion transfer tube p/n 70005-20606, Art.-Nr. 16-005 replaces the original ion transfer tube p/n 70005-20198. The adapter (b, Art.-Nr. 16-003) included in the interace kit TX7 can be directly mounted onto the original high-capacity ion transfer tube (p/n 80500-20045).

The MS interface enables the general connection of the SICRIT® Ion source to your Thermo Scientific MS. It also enables the mechanical connection of additional SICRIT® modules for coupling methods e.g. LC-SICRIT®-MS or GC-SICRIT®-MS (please check for available products at [plasmion.com](http://plasmion.com)).

a) Thermo IonMax Retrofit housing  
(Art.-Nr. 26-001)

Locking  
Levers

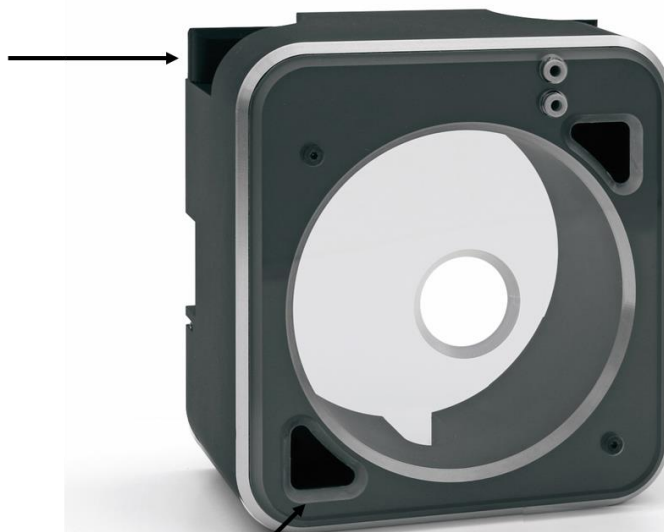

Rail Mount



b) Capillary Adapter  
(TX7, Art.-Nr. 16-003)





b) Ion Transfer Capillary  
(TX2, Art.-Nr. 16-005;  
TX3, Art.-Nr. 16-004)

Figure 1: Components of the SICRIT® MS Interface TX2 / TX3 / TX7.

## 2. Installation of the SICRIT® MS Interface TX2 / TX3 to the MS Instrument

### 2.1 Steps before the installation of SICRIT® MS Interface TX2 / TX3 / TX7

Before the interface can be installed to the mount of the Thermo MS, the standard *Ion Max* housing must be removed. Please follow the specific descriptions of the manufacturer of your MS.

	<p>Attention!</p> <p>Plasmion GmbH does not hold responsibility for potential damages that result from non-compliance to the manuals of the MS-manufacturer when removing the housing or other parts of the MS.</p>
	<p>Attention!</p> <p>Some parts of the MS interface can be very hot and cause burnings or injuries. Before performing the installation, let the system cool down, wear protective gear and refer to the instructions given in the respective MS manual.</p>

- Put your MS instrument in standby mode and let *the ion sweep cone* cool down.
- Unlock the lever on the housing and take it out of the mounting.
- Unscrew both screws connected to the *ion sweep cone* and take the cone off.
- Now the transfer capillary can be dismantled with the specific tool of the MS-manufacturer (Figure 1 a). Make sure not to remove or damage the graphite sealing ring. After successful removal, the MS inlet should look as shown in Figure 1 b.

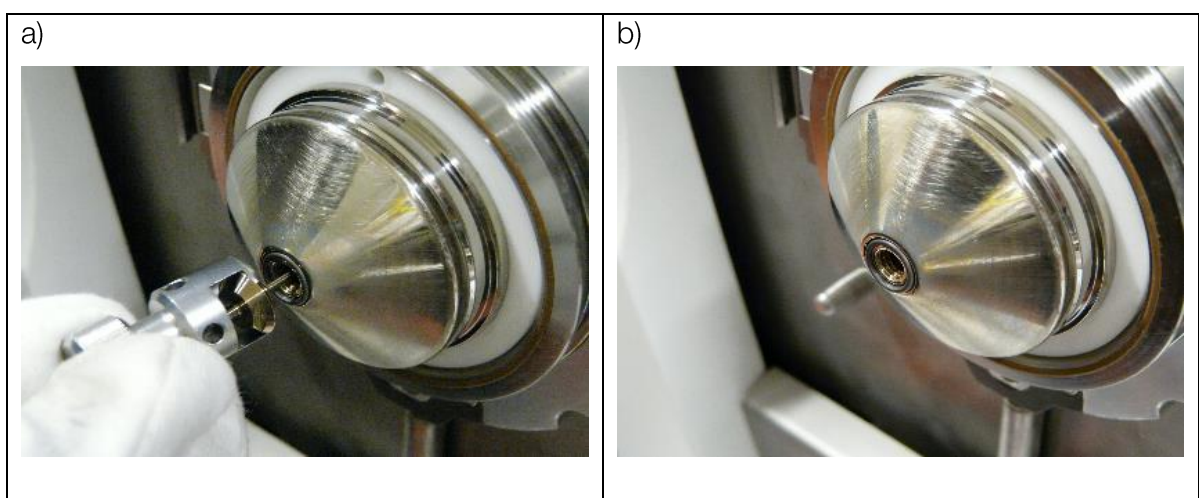

Figure 2: Removing the ion transfer capillary with the MS manufacturer tool.

## 2.2 Installation of the SICRIT® Inlet capillary

For the operation of the SICRIT® Ion source, a special inlet capillary fitting your MS is required and provided with this interface. The capillary provided with the TX2 interface replaces the original capillary with *P/N 97055-20198* (101.6 mm). The capillary provided with the TX3 interface replaces the original capillary with *P/N 70005-20606* (58.42 mm). The ion source adapter provided with the TX6 interface will fit to the original ion transfer tube with *P/N 80500-20045*. This adapter can be directly slid onto the ion transfer tube without removing the capillary.



If your original Thermo capillary differs in length from the one provided with the interface, please contact Plasmion or your respective sales agent before installation.

Insert the SICRIT® Inlet capillary through the *Spray Cone* opening. Make sure that the graphite sealing ring is positioned correctly (Figure 2).

- Fix the inlet capillary with a 13 mm open-end wrench (only hand tight!).
- Control the tight fit of the capillary with the shown pre-pressure (< 2 mbar) in the status window of the MS software.



Figure 3: Installation of the SICRIT® Ion transfer capillary.



Make sure that the capillary inserts as easily as the original capillary. If you sense an unusual resistance when inserting the capillary pull it out immediately. The capillary inlet could be deformed through the effect of the heat.



## 2.3 Installation of the SICRIT® Ion source

After mounting the SICRIT® Ion transfer capillary, the SICRIT® Ion source can be mounted (Figure 4).

- Press the ion source gently onto the source adapter.
- Firmly hold the source and rotate the lock about  $\frac{1}{4}$  turns clockwise, until you hear a “click” sound. This signalizes that the lock is secured, and mounting is finished.

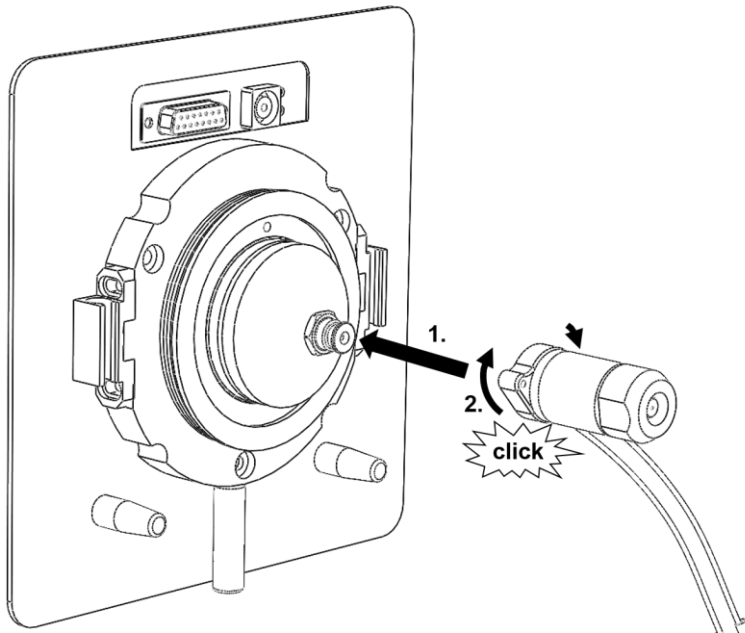

Figure 4: Installation of the SICRIT® Ion source.



On new sources the locking might require some force. The locking mechanism becomes easier after a few installations.

## 2.4 Installation of the SICRIT® IonMax Source retrofit housing

For the installation of the SICRIT® Ion source to Thermo Scientific LC-MS systems, the SICRIT® MS housing is used on the ion source mount instead of the *Ion Max API* housing.

- Move the HV cables of ion source through the cutouts on the bottom of the source housing.
- Adjust the two holes of the source housing to the guiding pins of the mount and press the housing gently onto the mount.
- Lock the two levers on the source housing by turning them 90 degrees.
- Check the correct installation by the status message “*Instrument status ok*” in the MS software.

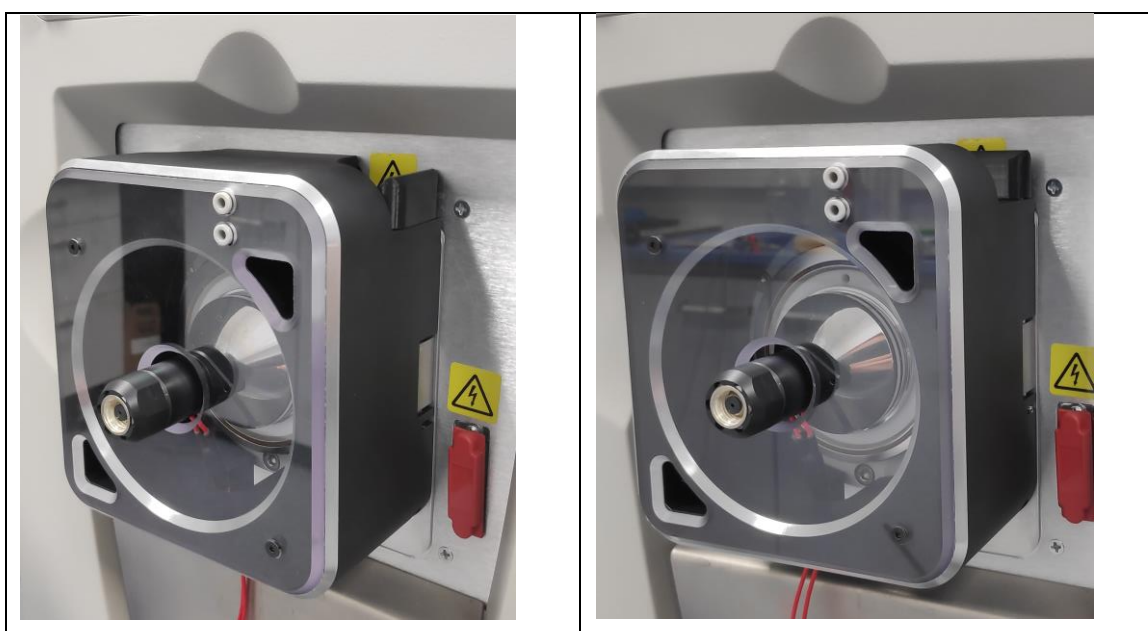

Figure 5: Installation of the SICRIT® MS Source housing to the mount of the MS instrument by locking the levers.

After installation of the source housing, the SICRIT® Ion source should be detected as standard ESI source by the MS-instrument.



### Attention!

Make sure not to jam the HV cables while attaching the source housing! Use the provided cutouts (see Fig. 5). Avoid bending the cables (minimal bending radius is 4 cm). Do not place the cables over sharp edges or hot surfaces. Avoid strain on the cables and use strain relief measures.

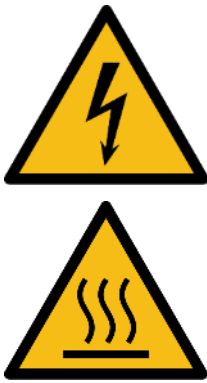
	<p>Attention!</p> <p>Do not remove the surface cover plate of the SICRIT® MS Source housing.</p> <p>The cover plate is meant to protect the user for unintended contact with hot and/or electrically live components of the MS instrument or the ion source in the event of operation not according to the instructions given in this manual.</p>
---	---

Further information about the intended use of the SICRIT® Ion source and the implementation of SICRIT® MS-measurements or measurements with coupling of GC or SPME can be found in the corresponding manuals of Plasmion GmbH.

If you need further assistance or support, please contact Plasmion via [support@plasmion.com](mailto:support@plasmion.com).

### 3. Launching the MS instrument with SICRIT® Ion Source Technology



If the system is used in a way not specified by the manufacturer, the warranty of the system may be voided.

#### Thermo MS Software Settings for the Operation with SICRIT® Ion source

The SICRIT® Ion source replaces the standard *API ion sources* like ESI or APCI. Before assembling and launching the SICRIT® Ion source the following recommended operation parameters should be set in the MS software (Table 1):

Table 1: Recommended software source settings for SICRIT® ionization

Setting	Recommended Values
Sheath Gas Flow Rate	0 (except if used for optional modules)
Aux Gas Flow Rate	0 (except if used for GC/SPME Module)
Spray Voltage	0 kV
Capillary Temperature	150°C - 250 °C



Plasmion GmbH refuses any liability for damage to persons, its own or foreign products if other than the above-mentioned recommended settings are used during SICRIT® MS operation!

## 4. Service and Maintenance of the SICRIT® MS Interface TX2 / TX3 / TX7

### 4.1 Maintenance of the SICRIT® Ion transfer capillary and adapter parts

It is recommended to clean the capillary and source adapter parts to avoid the formation of contaminations in form of deposits and to ensure an optimum performance of the ion source. A drop in the pre-pressure indicates a clogging of the inlet capillary due to high particle load and requires the cleaning of the capillary. To remove the inlet capillary, stick to the steps described above for replacing the Thermo Scientific ion transfer tube with the SICRIT® Ion transfer capillary.

- Put your MS to standby mode and let the *spray cone* cool down.
- Turn off the SICRIT® SC-30 control unit's HV output.

	<p>Attention!</p> <p>Ensure the MS instrument is in standby and HV is turned off at SICRIT HV supply before continuing.</p>
--	---

- Disconnect the HV cables.
- Unlock the levers of the SICRIT® MS Source housing and take the housing off carefully.
- Take off the SICRIT® Ion source.

	<p>Attention!</p> <p>The capillary and the adapter parts might be very hot!</p> <p>Let it cool down first and wear appropriate protective gear.</p>
---	---

- Dismantle the ion transfer capillary with a 13 mm open-end wrench.
- Carefully pull the ion transfer capillary out of the MS inlet. Make sure not to remove or damage the graphite sealing ring.

### 4.2 Cleaning of the SICRIT® Ion transfer capillary and adapter parts

Follow the procedure below to clean the SICRIT® Ion transfer capillary or the adapter parts:

- Use a thin steel wire (0.5 mm) to remove particles or clogging within the capillary
- Use an ultrasonic cleaning bath to clean the transfer capillary or adapter parts for 15 min in a 50:50 methanol: water-mixture.
- Check the graphite sealing ring for damage and replace it by a new sealing ring if necessary.

- If necessary, clean the source housing and protective window using a moist linen tissue.
- Insert the SICRIT® Ion transfer capillary as described above and control the pre-vacuum shown in the status monitor of the MS software.